



**Instructor
Copy**

WELCOME TO AKA SCIENCE!

For the next 4 class sessions, you and your students will embark on a virtual journey of scientific discovery that explores the exciting worlds of biology, chemistry, physics, and engineering. We hope you enjoy the ride!

AKA Science is funded by our generous community partners.

- ABOUT YOUR KIT -

CLASS FLOW:

Class 1: Explore your world (observe Biology)

- Pre-Activity – *AKA Science Pre-Survey*
- Activity 1 – *Insect Sounds*
- Activity 2 – *Frog Tongue*
- Activity 3 – *★Eating Contest★*

Class 2: Explore Matter (experiment with Chemistry)

- Activity 1 – *Flexible Fish*
- Activity 2 – *Cool Chromatography*
- Activity 3 – *★Lava Lamps★*
- Activity 4 – *Milk Motion*

Class 3: Explore Light (investigate Physics)

- Activity 1 – *Blind Spot*
- Activity 2 – *★Glowing Streak / Glowing Water★*
- Activity 3 – *Fun House Mirrors*
- Activity 4 – *Not in Kansas Anymore*

Class 4: Explore Forces (build with Physics & Engineering)

- Activity 1 – *Gumdrop Toothpick Tower*
- Activity 2 – *Pinwheels*
- Activity 3 – *Spool Racer*
- Activity 4 – *★Cartesian Diver★*
- Post-Activity – *AKA Science Post-Survey*

GENERAL SUPPLY BAG:

The "General Supply Bag" includes supplies that are used throughout the course (i.e. used in multiple classes and activities.) Each individual class will have its own additional list of supplies needed for that day's particular set of activities. **Please remind your students to return all general supplies to the bag at the end of each session.**

General Supply Bag contents:

- Cup (9oz, plastic punch) x 1
- Lab Notebook x 1
- Magnifying Glass x 1
- Pencil x 1
- Scissors x 1
- Tape (scotch, roll) x 1

Virtual Learning:

Session II

BEFORE YOU START:

- ★ Activities marked with stars are student favorites! **Pre- and post-survey questions will pertain to the topics covered in these activities.** If you have limited time, these activities should be prioritized; please take special care to include the survey themes into your discussion of the activity.
- Discuss and establish basic science safety protocol with your students. **NOTHING from their AKA Science kit should go in their mouths, nose, eyes, or ears.** If students have younger siblings, make sure those younger siblings do not have access to the AKA Science supplies.
- Some activities involve water or other liquids. **Please make sure students are placing their laptop/Chromebook/phone in a position/place where any accidental spills will not damage their technology!**
- Lab Notebooks and pen/pencil is listed as a supply for each activity so that students can record observations and brainstorm ideas in their notebooks as they go. **Please encourage students to use their Lab Notebooks!**
- **SPECIAL NOTE:** The “Science Behind It” section within this curriculum is designed to be supplemental information for you, the Class Leader, and the student if they are interested. **You do NOT have to read the Science Behind It section aloud** (unless you want to).

CLASS 1: EXPLORE YOUR WORLD (OBSERVE BIOLOGY)

Pre-Activity: AKA Science Pre-Survey

- Please conduct a pre-survey at the **BEGINNING of the FIRST class** by asking the questions below and **record each student's response**.
- **Read each question and its possible answers aloud** as well as typing the questions/possible answers into the chat box of your virtual learning platform.
- **The following are options for survey response collection:**
 1. **Administer the survey in real-time during the class session. We recommend the following method:**
 - a. **Have students close their eyes** or put their heads down (for anonymity among peers) and **respond to the questions by raising their hands**.
 - b. **Record each student's response** (e.g. Kerry said "boring", Kevin said "fun", Kamil said "Sorta fun"). Students' responses will be compared to their post-survey responses at the end of the program to assess learning growth.

All student responses must be passed along to Kathryn Sechrist via email at (ksechrist@impactnw.org).

2. **If it is easier for your students, they can fill out a simple Google Form.** This can be found at www.tinyurl.com/AKASciencePre3.
 - a. **Enter the link into the virtual classroom chatbox** and have students complete the survey then and there.
 - b. **Please be sure your students complete the survey!** You might want to copy/paste the link into the chatbox several times to ensure students access the survey and give students time to complete the survey before you delve into the activities.

SURVEY QUESTIONS:

1. **Do you think that science is _____?**
 - a) Fun
 - b) Sort of fun
 - c) Boring
2. **Do you like doing science experiments?**
 - a) Yes
 - b) Sort of
 - c) No
3. **Do you want to learn more about science?**
 - a) Yes
 - b) Sort of
 - c) No
4. **What do you call the features of living things that help them survive?**
 - a) Classification
 - b)
 - c) Dispersals
5. **When you add Alka-Seltzer to water, what gas is produced that causes it to bubble and fizz?**
 - a) Laughing Gas
 - b)
 - c) Water Vapor
6. **True or False? Ultraviolet (UV) light causes fluorescent highlights to glow.**
 - a)
 - b) False
7. **True or False? Air pressure affects whether an object sinks or floats:**
 - a)
 - b) False

Activity One – Insect Sounds

Time: 25 Minutes

Supplies:

General Supply Bag	#
Pencil	1
Lab Notebook	1
Scissors	1
Tape	1
Class 1 Supply Bag	#
Foam squares (adhesive)	4
Index cards (3inx5in)	1
Index cards (half-size, 3inx2.5in, assorted colors)	1
Nail files (disposable)	1
Popsicle sticks (jumbo)	1
Rubber bands (size 64)	1
Yarn (2ft pieces)	1

Goal: To investigate different techniques insects use to produce noise by scraping a nail file on an index card and building a contraption that buzzes when it spins & vibrates.

Survey Connection:



- Q.** What do you call the features of living things that hel them survive?
A. Adaptations

Procedure:

1. Start a discussion about insect sounds.

Discussion Prompts:

- **Why do you think insects make sounds?**
- **What types of sounds can insects make?** (*Hissing, buzzing, chirping, etc.*)
- **Can we make sounds like insects? Let's try!**

2. Have students grit their teeth and quickly blow air out of their mouth.

Discussion Prompts:

- **What did that sound like?** (*A hiss!*)

Virtual Learning:

Session II

- **Can you think of any insects that sound like that?** (Cockroaches push air quickly through a tiny breathing hole called a spiracle, creating the same sound.)
 - **What are some other insect sounds we can make?**
3. Each student should have a half-size index card (3inx2.5in, solid-colored) and a nail file.

Discussion Prompt:

- **How can we make noise with these supplies?**

4. Hold the file in one hand and the index card in the other (see diagram at right).
5. Drag the nail file over the edge of the card. Experiment with different angles and speeds.

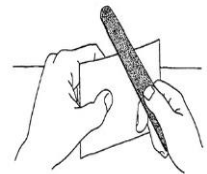

Discussion Prompts:

- **Which insects sound like that?** (Grasshoppers and crickets make sounds with this method, known as **stridulation**, by dragging their rough legs over the sharp edges of their wings.)
- **Can we make something that buzzes? Let's make a buzzing card!**

6. Each student should have a jumbo popsicle stick, a 2ft piece of yarn, a rubber band (thick, size 64), four foam squares, and an index card.
7. Cut the white 3x5in index card in half the long way.
8. Have students:

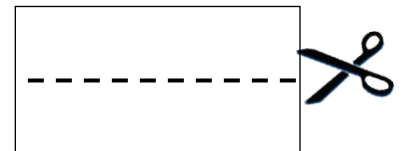

- Lay the jumbo popsicle stick in front of them horizontally.
- Lay the index card on top of the popsicle stick. The long side of the index card should line up with the long side of the popsicle stick. The index card should overlap the popsicle stick halfway up (see diagram & photo).
- Tape the long side of the index card to the stick. (Use a piece of tape that's 3-4 inches long. It will be shorter than the length of the index card.)
- Tie one end of the 2ft piece of yarn to one end of the stick with a double knot.

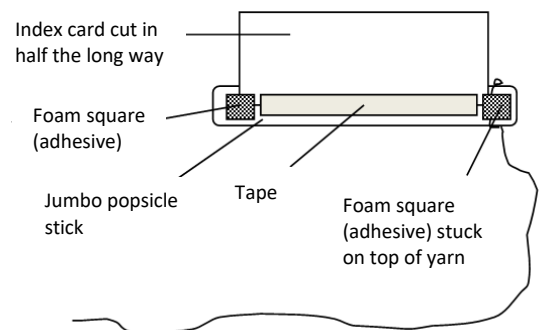

Virtual Learning: Session II

- e. Slide the knot to the narrow top or bottom edge of the stick (see middle photo on right).
- f. Peel the backing off a foam square and press it on top of the yarn, securing the yarn to the stick. (The square may also overlap the card.)
- g. Repeat with another foam square on the other side of the stick.
- h. Add the final two foam squares to the other end of the stick (both sides).
- i. Stretch the rubber band around the length of the popsicle stick.
- j. If the loose end of the yarn is stuck under the rubber band, free it by pulling it from under the rubber band. Students should be able to hold one end of the yarn while the rest of the contraption hangs down.

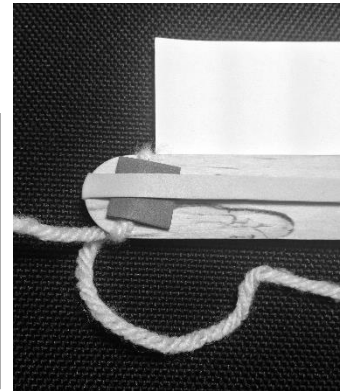
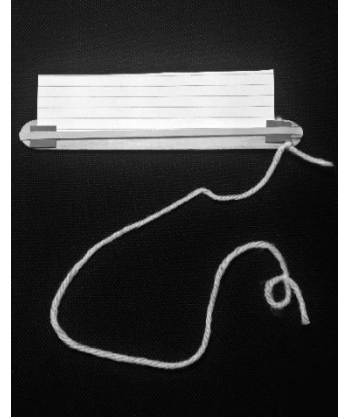

- TIPS:**
- You might want to demonstrate to students how to stretch the rubber band.
 - If needed, students can hold the foam squares in place against the popsicle stick until the rubber band is in place.
 - Make sure the rubber band isn't twisted, and make sure index card has enough room to vibrate between the rubber band and popsicle stick.

9. Ask students: **How do you think we could make noise with this contraption?**
10. To use the buzzing card, have students:
 - a. Stand at least 3 feet apart from anyone or anything.
 - b. Holding the yarn at the loose end, twirl the buzzing card in a circle in front of them or to one side (see photo at left).
 - c. To stop the card, stick out an index finger and let the yarn wind around it.



Discussion Prompts:

- **What happened?** (The contraption – similar to a musical instrument called a bullroarer – made a buzzing sound.)
- **Why do you think that happened?** (Air moved around the index card and caused it to vibrate against the rubber band and index card. This vibration produced sound.)
- **What did it sound like?** (Like a buzzing bee or other insect! The buzzing sound that insects make is caused by vibration as their wings beat against the air.)

11. Have students spin the card faster or slower or hold the string closer to the card.

Virtual Learning:

Session II

Discussion Prompts:

- **How did those changes affect the sound?** (Faster spinning may make the sound louder and/or higher. Slower spinning may make a quieter, lower sound.)

The Science Behind It:

When you spun the card around, rushing air wiggled the card, making vibrations so fast that you heard them as a buzzing sound. There's a reason it sounded like the buzzing of bees, flies, and wasps: their wings move and vibrate the air just like your card, making that distinct "bzzzz" sound.

All sound is a form of vibration. When bugs expel air or move their wings, they vibrate the air around them, which makes noise. Insects themselves have ears that are different than human ears, and they can be located in different places on the body, depending on the insect—from wings, to chests, to legs. Most insects also have tiny hairs all over their bodies that sense vibrations. (www.scientificamerican.com/article/why-do-bees-buzz/, www.thenakedscientists.com/articles/interviews/how-do-insects-hear/)

Activity Source: Adapted from: www.kiwicrate.com/blog/4796/buzzing-bee-noisemaker/

Activity Two – Frog Tongue

Time: 10 Minutes

Supplies:

General Supply Bag	#
Pencil	1
Lab Notebook	1
Class 1 Supply Bag	#
Felt (small pieces, assorted colors)	5
Party blowouts	1
Velcro circles (hooks/rough side only, adhesive)	1

Goal: To investigate how frogs' tongues are adapted for catching flies by exploring a model using a party blowout and small pieces of felt.

Survey Connection:



- Q.** What do you call the features of living things that help them survive?
A. Adaptations.

Procedure:

1. Ask students: **How do you think animals get their food?**
2. Allow students a few seconds to think about the question. Have them discuss their answers as a class.
3. Depending on their responses, here are some additional examples of how animals get their food:
 - *By catching it with mouths/beaks;*
 - *Hunting and capturing it with claws/tentacles;*
 - *Trapping it;*
 - *Pulling in water that contains food particles;*
 - *Filtering out the water;*
 - *Eating grass, plants, berries, gathering nuts.*
4. Transition into a class discussion about insectivores (insect-eaters):

Discussion Prompts:

- **Can you think of anything that eats insects?** (*Spiders, fish, frogs, lizards, birds, anteaters, bats, Venus flytraps, other insects like dragonflies and hornets, plus people in many parts of the world!*)

Virtual Learning:

Session II

- **Spiders have adapted to catch insects in webs. How do frogs catch insects? Let's find out!**

TIPS:

- **Let students know that this activity is a very rare time when it's OK to put AKA Science supplies in their mouth.**
- **Make sure students wash their hands before putting the party blowout in their mouth.**

- Each student has a party blowout ("frog tongue") and a Velcro circle.
- Have students:
 - Unroll the party blowout with their hands.
 - Remove the Velcro circle from its backing.
 - Stick the Velcro circle on the underside of the blowout (near the tip).
- Tell students that this is a model of a frog tongue and they will use it to catch flies!
- Each student has around five small pieces of felt (these are the "flies").
- Have students:
 - Spread the "flies" out on a flat surface (like a desk or table).
 - Put the blowing end of the frog tongue in their mouth and hold it in place.
 - Try picking up flies with the frog tongue (it may take some practice).

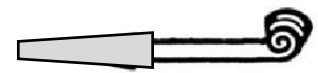

Unroll the party blowout by hand.

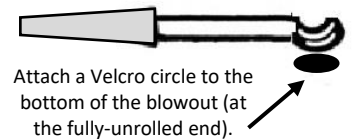

Attach a Velcro circle to the bottom of the blowout (at the fully-unrolled end).

Discussion Prompts:

- **Were you able to catch the flies?**
- **What did you notice about the frog tongue?** (It unrolled and rerolled quickly. It may have taken some practice to aim it accurately.)
- **How is it helpful for a frog to have a tongue that moves fast and stretches out far away from its body?** (A frog can stay still and wait until flies are in close range, then its tongue reaches out and catches them by surprise.)
- **What do frogs get from eating insects as food, besides a delicious treat?** (The energy to live, move, and grow!)

- If time allows, have students race to see who can catch their flies the quickest. They can "ribbit" or make a frog sound when they "eat" all their flies!

The Science Behind It:

Frogs are very well-adapted predators. They're famous for eating flies, but they also eat other insects and small animals. A frog hunts by quietly waiting for its prey to come close, then quickly flicking its sticky tongue out and pulling the prey into its mouth.

Unlike a human's tongue, which is attached in the back of our mouth, a frog's tongue is attached to the front. This makes it so a frog can throw its tongue towards its meal. A frog's tongue is very strong: it can lift 1.4 times its own body weight. That would be like a 90-lb person lifting a 126-lb person - with only their tongue! A frog's mouth also

Virtual Learning:

Session II

has numerous small teeth that form a cage around its captured prey, preventing it from escaping. Even with all those teeth, frogs don't need to chew their food—they swallow it whole. Frogs can even contort their eye sockets to help push the food down.

(nationalgeographic.com/2014/06/12/frogs-animals-weird-science-tongues-adhesive-science/)

Activity Source: Inspired by: totallytots.blogspot.com/2010/09/once-upon-book-mixed-up-chameleon.html

Activity Three – Eating Contest

Time: 20 Minutes

Supplies:

General Supply Bag	#
Pencil	1
Lab Notebook	1
Class 1 Supply Bag	#
Bowl (paper)	1
Marbles (small)	2
Mini Clothespin	1
Plate (paper)	2
Plastic fork	1
Plastic spoon	1
Plastic tweezer	1
Rice container	1
Sand bag	1
Yarn bag (1 in pieces)	1
Folder	#
Worksheets: Beak Types - Water Birds	1
Worksheets: Beak Types - Land Birds	1

Goal: To investigate how bird beaks are adapted for eating different types of foods by exploring tweezers, mini clothespins, spoons, and forks as model beaks. To explore how different beak shapes help with eating different types of food.

Survey Connection:



- Q.** What do you call the features of living things that help them survive?
A. Adaptations.

Procedure:

1. Start a discussion about types of bird beaks and types of foods that birds eat.

Discussion Prompts:

- Some birds eat insects—but there are many types of birds, and they eat different types of food. **Do you think an insect-eating bird would be able to eat fish?**
- **Would a meat-eating bird be able to eat seeds? Let's find out!**
- **Do all bird beaks look the same?** (No – different birds have different types of beaks.)

Virtual Learning:

Session II

2. Explain to students that they will be using some everyday objects as models of different beak types.
3. Each student should have a fork, a spoon, tweezers, and a mini clothespin. Have students decide which of the four “beaks” they will start with.
4. Students will use their plate to set up four unique “foods” that they test their “beak” with. Start with ONE type of food at a time (e.g. vial of rice)

Students should prepare:

- a. **Half the container of rice**
 - b. **Pile of yarn** (Note: when it's time to “eat” the yarn, spread out the pieces of yarn on the plate)
 - c. **2 marbles** (Note: when it's time to “eat” the marbles, make sure they stay on the plate!)
 - d. **Bowl of rice & sand** (Note: Take half of the container of rice and mix with sand in the bowl)
5. Explain to students that each of these four “foods” represents a different kind of food that birds might eat. Your job will be to use your “beak” to try to pick up (or “eat”) each type of “food.” **NOTE: Do not actually EAT the “food”!!!!**

RULES:

- **You can only work on ONE type of food item at a time** (e.g. start with the rice). It's best if the whole class starts does the same “food” at the same time.
- **You can only pick up ONE food bit at a time** (e.g. one grain of rice, one marble, one piece of yarn).
- **You can ONLY use your beak** to pick up the food. **Note:** Your beak may not be able to pick up that many food items (e.g. the rice might slip through the fork) and that's OKAY!
- **You can only use one hand (the hand with the “beak”) to “eat” the food.**
- **The food has to be on the plate while you “eat” and you can put what you eat into their Ziplock bag** (e.g. you can't pick up the vial or pour the rice onto your spoon, etc.)
- **Before you move on to the next type of food, you must empty out your Ziplock bag** (i.e. your “stomach”) so that the bag is empty before you start your next “food.”

Discussion Prompt:

- **Which beaks do you think will work better for picking up each type of food?**
6. **For added challenge,** impose a time limit (e.g. 1 minute) for each type of “food.” For example, have your class start with the rice and set a timer so that everyone uses their beaks to pick up the grains of rice for one minute then once the time elapses, have everyone record how many grains of rice they got during that minute.

Virtual Learning:

Session II

7. Once everyone has finished with the first type of “food,” ask students:
 - **Who got the most food?**
 - **Which beak worked best with this type of food?**
 - **Were any of the beaks hard to use on this type of food?**
8. Have students empty out their “stomach” (Ziplock bag) and put the “food” back to the best of their ability (e.g. rice back into the container). Get the next type of “food” ready (e.g. the pieces of yarn).
9. Each student will keep their same beak for now.
10. Repeat the activity until each group has explored all four types of “food” with their beak.
11. Once completed, facilitate a discussion about which beak types were best for which types of food.

Discussion Prompts:

- **Were some types of beaks better for picking up certain foods?** (*Yes. Each beak was a good fit for some types of food, but may not have worked as well for other types of food.*)
 - **Why do you think real birds have different types of beaks?** (*Bird beaks are tailored to the food that’s available in different environments.*)
 - **What do we call the features of living things—like birds’ varying beak styles—that help them survive in different ways?** (*Adaptations! Each beak design is an adaptation for eating a certain kind of food.*)
12. If time allows, repeat the activity using a different beak, or students can explore freely and try out all the beaks. **Please remind your students to return all their general supplies back into their General Supply Kit.**
 13. Ask each student to pull out the two “Beak Types” worksheet (Land Birds and Water Birds).

Discussion Prompts:

- **Do you think our beak models are anything like real bird beaks?**
- **What did you notice?**
- **Did anything surprise you?**
- **Have you ever seen birds with any of these types of beaks?**

The Science Behind It:

Birds’ beaks are well-adapted to pick up the type of food each bird eats. Seed-eaters have big, sturdy beaks to crush open seeds. Woodpeckers have pointed, chisel-like beaks to drill into trees for insects. Some birds have sharp, pointed beaks to spear fish, while other birds have beaks they can open up wide (like a net) to catch flying bugs. (http://fsc.fernbank.edu/birding/bird_beaks.htm)

Activity Source: <http://pubs.usgs.gov/of/1998/of98-805/lessons/chpt2/act5.htm>

CLASS 2: EXPLORE MATTER (EXPERIMENT WITH CHEMISTRY)

Activity One – Flexible Fish

Time: 5 Minutes

Supplies:

General Supply Bag	#
Pencil	1
Lab Notebook	1
Class 2 Supply Bag	#
Fortune Teller Fish	1
Paper towels (piece)	1

Goal: To learn about polymers by observing how cellophane interacts with moisture.

Procedure:

1. Each student should have a Fortune Teller Fish. Ask students **if they have ever seen a fortune teller fish?** It can't really tell your fortune, but there's some fun science behind it!
2. Have students remove the fish from its wrapper (without handling it too much) and set it flat on the table. Keep the wrapper nearby.

Discussion Prompts:

- **What properties does the fish have?** (It's red, transparent, thin, etc.)
- **What type of matter is it?** (Solid.) **Let's see how it acts if you put it on your hand instead of the table.**

3. Have students put the fish flat in the palm of their hand.

Discussion Prompt:

- **What happened?** (The fish started to wiggle and curl – see top photo.)

4. Have students put the fish on a dry part of their desk (it should stop moving).

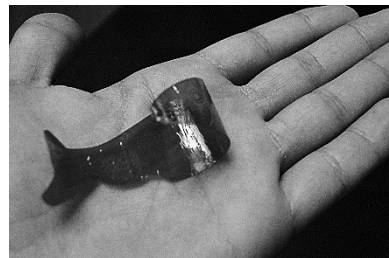

Discussion Prompts:

- **What do you think caused the fish to move?** (It could be heat or moisture from your hand.)
 - **How could you figure out whether heat vs. moisture is causing the effect?**
5. Have students lay the wrapper flat on their palm, then put the fish on top of it.

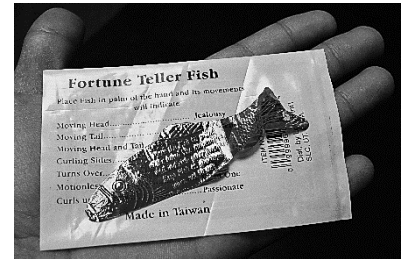

Discussion Prompts:

- **What happened?** (The fish didn't move.) **What effect do you think the plastic wrapper had?** (It blocked moisture from reaching the fish.) **Do you think it blocked heat?** (No.)
- **What can we rule out as a possible explanation for what makes the fish move?** (Heat.)
- **Our hypothesis is that moisture is what makes the fish move. How could we test that?**

TIP: • **Here's another way to rule out heat: put the fish near a warm, sunny window. It won't move. (Don't put the fish near a lamp, heater, etc.)**

6. Have students dip their paper towel into some water then wring it out so the paper towel is damp but not dripping.

Discussion Prompts:

- **Do you think this paper towel has more or less moisture than your hand?** (More.)
- **What do you think will happen if you put the fish on top of it?**



7. Have students lay the paper towel flat on the table, then put the fish on top of it.

Discussion Prompts:

- **What happened?** (The fish curled up even more than before!) If your students are familiar with the AKA Science Activity "Snow Day": **How is your fortune teller fish like the Instant Snow?** (They both have the property of absorbing water and responding in interesting ways. In fact, they're both highly absorbent polymers!)
8. If time allows, have students try doing jumping jacks or jogging in place to see whether working up a sweat increases the moisture on their palms.

Virtual Learning:

Session II

The Science Behind It:

The fish are made of cellophane, which is a naturally-occurring polymer that comes from wood. Cellophane absorbs water very easily. The palms of your hands have lots of sweat glands that produce moisture. When you place the fish on your palm, it absorbs the water from your sweat. As the cellophane absorbs the water, its molecules change shape and swell up, making the fish twist and turn (the main direction it curls depends on the "grain" of the cellophane). Cellophane is also thin enough that when you put it on the table, the water evaporates quickly, making it flatten back out.

(www.stevespanglerscience.com/lab/experiments/fortune-telling-fish, <http://cosmos.bgsu.edu/STEMinPark/>)

Activity Source: www.terrificscience.org &
www.polymerambassadors.org/FortuneFish.pdf

Activity Two – Cool Chromatography

Time: 10 Minutes

Supplies:

General Supply Bag	#
Pencil	1
Lab Notebook	1
Cup (9 oz, plastic, punch)	1
Class 2 Supply Bag	#
Coffee filters prepped with black ink circles (paper, round)	1
Coffee filters (paper, round)	1
Markers (black, wet-erase)	1
Plate (paper)	1

Goal: To perform chromatography with coffee filters and water to separate black marker ink into multiple colors of dye.

Procedure:

1. Start a group discussion about the color black.

Discussion Prompts:

- **What is the color black?**
- **Is it just one color or a mixture of different colors? Let's explore!**

2. Students should have: a pencil, a coffee filter, a black marker, a plate, and a 9oz cup that has water in it just up to the indent near the base of the cup.
3. Have students:
 - a. Draw a circle in the middle of the flattened coffee filter that is (see photo).

- TIP:**
- It may not be obvious where the flat part of the coffee filter ends and the wavy part begins. **The important thing is that the marker circles should be big enough that the water won't touch the black ink when the tip of the filter goes in the water.**
 - **Make sure the black marker line stays above the level of the water.** (Otherwise, the black ink will seep into the water in the cup, and the activity won't work very well.)

Virtual Learning:

Session II

OPTIONAL: If desired for a more dramatic effect, you could have students use a wet-erase marker to trace an additional black circle on their filter (over the existing one). Err on the side of making the 2nd circle slightly larger.

- b. Fold their filter in half 3 times to form a wedge ("like a pizza slice").
- c. Gently place the wedge in their cup point-down—so the tip of the filter is in the water—then let go (see top photo).

4. Have students watch as the water travels up the filter (see photo).

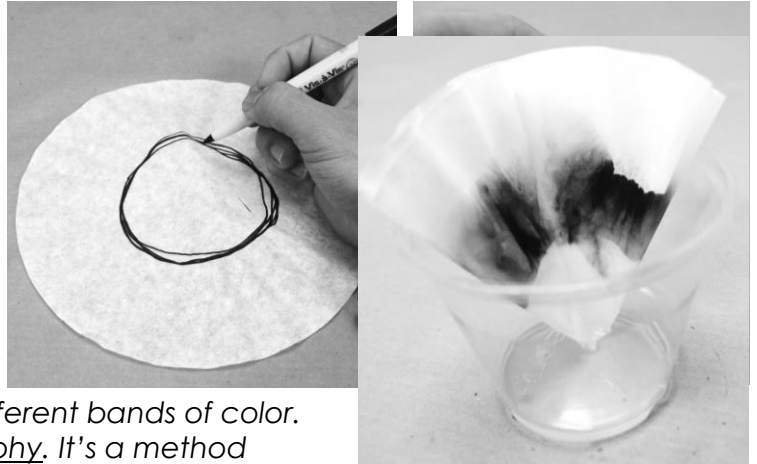

Discussion Prompts:

- **What do you notice?** (As the filter absorbs the water, the ink gets carried along with it. As the ink travels upward, it starts to spread out into different bands of color. This is called chromatography. It's a method scientists use to separate out different dyes and pigments.)
 - **What colors can you see separating out from the marker?** (Red, yellow, and blue.)
 - **Do you think different black markers would show different colors?** (The prepped filter was with a different type of black marker.)
5. After a few minutes, have students gently lift their filter out of the water (holding it by the edges) and spread it out over the top of the cup to dry.
 6. If time allows, have each student get out a blank coffee filter and a plate.
 7. Have students:
 - a. Put the new filter on the plate (so marker ink won't bleed onto the table).
 - b. Draw 5-7 large circles around the part of the filter where the flat part starts to become wavy (see photo).

- TIPS:**
- **It works best to remove the filter while the edges are still dry.** The marker ink will continue to travel a little further, even after the filter has been removed from the water.
 - **Tell students not to touch the wet ink on the filter,** since the ink will come off on their hands. (However, the ink can be washed off.)
 - **The filter will look best once the white part dries,** since it creates visual contrast with the separated colors.

- c. Remove their first filter from on top of the cup and lay it on the plate, ideally upside-down (the gap between the center of the filter and the plate will help the filter dry).
- d. Repeat the activity.
- e. **Please make sure students clean and return the 9oz cup to their General Supply Kit.**

Virtual Learning:

Session II

The Science Behind It:

Chromatography is a method that scientists use to separate out the different dyes in ink. When you put the coffee filter in the water, the water immediately spreads out through the paper via a process called capillary action. The ink gets dissolved in the water and moves along with it.

Ink is actually made of a mixture of different dyes. As the different dyes move with the water, some of them are more attracted to the paper, so they move slowly and stop soon. Some of the dyes are more attracted to the water, so they move quickly and travel farther away from the center of the paper. After a little while, the dyes separate so you can see each individual color. Different brands of black markers use different combinations of dyes. Even if the markers look the same when you write with them, the inks separate out differently.

Chromatography can be used in real life to figure out what things are used to make up ink and other liquids. You can use chromatography to separate out all the ingredients, then you can use different tests to find out what those ingredients are. Chromatography was used to figure out what makes leaves change colors. Scientists used chromatography to separate out the pigments in green leaves, proving that the leaves also have reds and oranges in them. (<http://www.webexhibits.org/causesofcolor/7E.html>, www.explainthatstuff.com/chromatography.html)

Activity Source: <http://www.stevespanglerscience.com/experiment/is-black-black>

Activity Three – Lava Lamps

Time: 15-20 Minutes

Supplies:

General Supply Bag	#
Pencil	1
Lab Notebook	1
Class 2 Supply Bag	#
Alka-Seltzer (container)	1
Bottles (8oz bottles, oil)	1
Color fizzers (small tablets, blue)	1

Goal: To create physical and chemical reactions by making a homemade “lava lamp” using Alka-Seltzer, oil, and water.

Survey Connection:



- Q.** When you add Alka-Seltzer to water, what gas is produced that causes it to bubble and fizz?
A. Carbon Dioxide (CO²)

Procedure:

1. Have a discussion with your class about lava lamps, which may be something your students (or you) have never heard of!

Discussion Prompts:

- **Have you ever seen a lava lamp before? Do you know how it works?** (A lava lamp contains two liquids inside a glass jar. The liquids have similar densities. When you turn the light bulb on, it heats up the liquids. Some of the liquid on the bottom expands and becomes slightly less dense, which causes it to float to the top. Once it rises to the top, away from the heat source, it cools down and sinks again.)
 - **How can we build a lava lamp that doesn't require a light bulb?**
2. **This activity includes water and oil. Please make sure students are working far from electronics!**
 3. Each student should have an 8oz water bottle, half full of oil. Instruct students to throw away the wrapper, if they have one. Keep the bottle cap handy for later in the activity. Have students fill their 9 oz punch cups with water.

Virtual Learning:

Session II

Discussion Prompt:

- **What do you think will happen if we add water on top of the oil in this bottle? Will they mix? If not, which will float on top? Let's find out!**
4. Now instruct students to carefully pour the water into the bottle. Fill until the total liquid is an adult finger width above the top indented line of the bottle.

TIP: • **If your room has a sink, it may be easier to add water to each bottle from the faucet.**

Discussion Prompts:

- **What happened?** *(The water and oil changed places! The oil still ended up on top.) Let's see what happens if we add some color.*
5. Each student should have a blue color fizzer.
6. Have students drop the color fizzer into their bottle.

Discussion Prompt:

- **What did you observe?** *(The color fizzer sank down through the oil because it was denser than the oil. When the color fizzer reached the layer of water, there was a burst of color and fizz as the tablet started dissolving in the water. Although some bubbles floated up into the layer of oil, the color fizzer only turned the water blue—not the oil.)*
7. Each student should have a container of broken Alka-Seltzer tablet.
8. Have students drop a quarter-piece of Alka-Seltzer into the bottle and observe.

Discussion Prompts:

- **What happened?** *(The Alka-Seltzer tablet reacted with the water to form bubbles of carbon dioxide.)*
 - **What type of matter is carbon dioxide—solid, liquid, or gas?** *(Gas.)*
 - **Do you think carbon dioxide gas is more or less dense than water?** *(Carbon dioxide is less dense than water. That's why the bubbles rise to the top of the liquid. When the gas rises, it carries some of the colored water up with it through the layer of oil. When the bubbles get to the top, they burst, and the water sinks back down. This continues until the Alka-Seltzer tablet is all used up and no more carbon dioxide gas is produced.)*
 - **Where else have you seen fizzy bubbles like the ones in the lava lamp?**
 - **Do you think you could make the lava lamp react again if you add more Alka-Seltzer?**
9. Once the initial reaction slows down, have students put their second quarter-piece of Alka-Seltzer in the bottle and observe.

Discussion Prompts:

- **Did it work?** *(Yes.)*

Virtual Learning:

Session II

- **What do you think will happen with a larger piece of Alka-Seltzer?**

10. Have students put the rest of their container (equivalent of a half-piece of Alka-Seltzer) in the bottle and observe.

Discussion Prompt:

- **What happened?** (There were even more bubbles that time, and they moved faster!)

11. Have students wait until their lava lamp stops reacting.

TIP:

- **DON'T let students put the cap on their Lava Lamp bottle until you no longer see bubbles forming.** If they put the cap on too soon, pressure can build up inside the bottle from gas that can't escape, which could cause the bottle to burst and/or leak and make an oily mess.

12. Each student should have a Ziploc sandwich bag.

13. Have students screw the cap on their bottle, then put the bottle in the Ziploc bag until they want to reactivate their lava lamps to show friends or family.

TIP:

- **Remind students that they should NOT eat the Alka-Seltzer tablets or use them for anything other than this experiment.**
- If students run out of tablets, there are DIY lava lamp options online that use baking powder or baking soda.

The Science Behind It:

There are three things going on here! Alka-Seltzer's reaction with water is a chemical reaction, because it produces something new: bubbles of carbon dioxide gas. The color fizzer also creates a brief chemical reaction because it contains the same ingredient as Alka-Seltzer. However, once the color fizzer stops fizzing, the remaining effect is a physical change: mixing the blue pigment with the water. Adding pigment or dye to something is different than creating a color change due to a chemical reaction. Real lava lamps work using density to get things moving, but instead of Alka-Seltzer, they use heat. By mixing just the right combination of chemicals, wax, and water, you can make a blob that moves up when it's warm and falls back down when it cools.

(www.acs.org/content/dam/acsorg/education/outreach/kidschemistry/activities/lava-lamp.pdf, www.oozinggoo.com/ll-form5.html, www.stevespanglerscience.com/green-fizzers-color-changing-tablets.html)

Activity Source: Inspired by Cool Concoctions

Activity Four – Milk Motion

Time: 10 Minutes

Supplies:

General Supply Bag	#
Cup (9oz, plastic, punch)	1
Pencil	1
Lab Notebook	1
Class 2 Supply Bag	#
Bowls (20oz, sturdy paper)	1
Cotton swabs (6in, wood handle)	1
Cups (1oz, plastic, calibrated)	1
Dish soap (small tube, green)	1
Milk (powdered, small bag)	1
Food coloring (small tube, assorted colors)	2
Spoons (plastic)	1

Goal: To explore the action of soap by observing how touching the surface of powdered milk with soap causes food coloring to mix and swirl.

Procedure:

1. Start a discussion about mixtures.

Discussion Prompts:

- **What happened when you mixed water and oil in the last activity?**
- **What happened when you added Alka-Seltzer tablets?**
- **Can you think of other mixtures that have surprising results?**

2. Each student should prepare a calibrated cup with 1oz of powdered milk.
3. Students should ready a 9oz cup, a plastic spoon, and a bowl.
4. Students may need to clean their 9oz cup from the last activity.
5. Empty the powdered milk into the bowl.
6. Fill up the 1oz calibrated cup with water and empty it into the bowl of powdered milk.
7. Use the spoon to stir the water/powdered milk mixture until it's thoroughly blended. When finished, let the mixture sit undisturbed so the milk stops swirling.
8. Students should have a tube of soap. Empty out the soap tube into the 9oz cup.

Discussion Prompts:

- **Do you know how soap works?** Soap molecules have a polar, hydrophilic (water-loving) head and a non-polar, hydrophobic (water-repelling) tail.

Virtual Learning:

Session II

A soap molecule attaches to water molecules with its polar head and to oil and grime with its non-polar tail. This helps suspend fats and dirt in the water so they can be more easily washed away. **Let's use this property of soap to make the milk move without touching it!**

- Students should have two small tubes of food coloring. Cut a **small** slit at the top and add four drops of food coloring into the bowl: two drops of the first color (across from each other, near opposite sides of the bowl) and two drops of the other color (perpendicular to the first set, also across from each other near opposite sides of the bowl).

CAUTION: Food coloring will stain hands and clothes.

- **Add the drops of food coloring close to the surface of the milk to minimize splashing.**
- **Tell students they can only touch the liquid with their cotton swab, and only when instructed.**
- **They can put the tubes in the calibrated cup to prevent mess.**

Discussion Prompts:

- **What do you notice about the food coloring?** (The color spread out a little bit on the surface of the milk, but otherwise, not much is happening.)
- **Knowing that soap grabs onto water and fat molecules at the same time, what do you think will happen if you dip a cotton swab in the soap, then place the soap on each dot of food coloring? Let's find out! Dip your cotton swab in the soap, and when I say "go," put it in.**

- Have students dip their cotton swab in the soap and get ready (hold the swabs off to the side of the bowl, and don't jostle the bowl).
- When you say, "Go," have students place the soaped end of their cotton swab in the milk at the same time. Tell them to aim for the middle of one color.
- Have students observe what happens, then put their cotton swabs back in the 9oz cup. (It helps to keep the swabs in the 9oz cup when not in use to avoid a mess.)
- After a moment, have students re-dip their cotton swab in the soap, then press and hold it in the milk, near where one of the other drops of food coloring was (even if they can't see it clearly).
- Have them put their cotton swab back in the cup while students observe.
- Have the students repeat the process with each of the other color drop in different areas of the bowl until the soap no longer causes a visible change.



Discussion Prompts:

- **What happened?** (The food coloring moved away from the soap, which caused the different colors to move around and swirl together.)

Virtual Learning:

Session II

- **Why do you think that happened?** *(The soap molecules get busy attaching to the fat and water molecules in the milk. The food coloring made the motion within the liquid easy to see. As a result of this motion, the colors blended. Once the soap molecules attached to all of the fat molecules in the milk, the reaction stopped.)*
16. If you have time and leftover food coloring, you can try the same activity with a cup of water to see if the reaction is the same.
 17. **Please make sure students clean their 9oz punch cup and return to their General Supply Kit.**

The Science Behind It:

Let's think about the three players in this experiment: milk, food coloring, and soap. Milk is mostly water, but it's not clear like water because it has fat, proteins, and other nutrients suspended in it. Food coloring is mostly dyed water. Soap is a very special molecule! Soap is a molecule with two different ends. One end loves water, and the other end loves fat.

When you put soap in a mixture of fat and water, one end of the soap attaches to water molecules, and the other end attaches to fat molecules. In this experiment, there were a lot of water molecules, but the fat was suspended in the milk. When you touched the surface of the milk with your soapy Q-tip, the soap raced out to find fat molecules and attach them to water molecules in a continuous process that caused the surface of the liquid to move. The food dye particles went along for the crazy ride, and helped you see how the milk, soap, and water moved! Soap's special property is what makes it so good for washing your hands! The soap clumps around the oil and dirt on your hands, then washes away under running water.

(www.stevespanglerscience.com/lab/experiments/milk-color-explosion/)

Activity Source: www.stevespanglerscience.com/experiment/milk-color-explosion & thanks to Katie Bryars Wenner

CLASS 3: EXPLORE LIGHT (INVESTIGATE PHYSICS)

Activity One – Blind Spot

Time: 5 Minutes

Supplies:

General Supply Bag	#
Pencil	1
Lab Notebook	1
Class 3 Supply Bag	#
Eyepatch	1
Folder	#
Worksheets: Blind Spot (strips)	1

Goal: Explore our natural blind-spots using a vision exercise

Procedure:

- Each student should have a Blind Spot strip in their folder. Have them hold it so that the star is on the left and the dot is on the right.
- Have students cover their left eye with a hand or their eyepatch and hold the strip about an inch from their face with one hand, with the star on the left.
 - Focus on looking at the star and notice the dot visible in their peripheral vision. Make sure the star is on the same side as the eye patch (e.g. both on the left.)
 - Slowly* move the paper away from their face, staring at the star, and watch for the moment as the dot disappears and then reappears in their peripheral vision.
 - If students don't see the dot disappear and reappear, they can try covering their right eye instead of their left.

Discussion Prompts:

- What happened?**
 - Why did the dot disappear?**
 - Where else do we talk about blind spots?**
- If time allows, have students draw a straight line between the star and the dot with a pencil, then repeat the activity. When the dot disappears, it looks like the line goes straight through the empty space!

The Science Behind It: The retina receives light and turns it into signals. However, at the spot where the optic nerve exits the eyeball retina can't receive light, which creates a small blind spot in our field of vision. Usually, the brain fills in the gap with information

Virtual Learning: Session II

from our environment and our other eye, so we're not aware that anything is missing. Some animals don't have blind spots! An octopus doesn't have a blind spot because the nerves in its eyes don't block any cells, so its whole eye is able to see.

(<https://faculty.washington.edu/chudler/chvision.html>)

Activity Source: *Biology Life on Earth - 7th ed. by Teresa & Gerald Audesirk & Bruce Byers and <http://www.aaofoundation.org/what/heritage/upload/Eye%20Openers.pdf>*

Activity Two – Glowing Streak / Glowing Water

Time: 15 Minutes

Supplies:

General Supply Bag	#
Cup (9oz, plastic, punch)	1
Pencil	1
Lab Notebook	1
Class 3 Supply Bag	#
Highlighters (yellow)	1
LED Lights (blue)	1
Markers (yellow)	1
Folder	#
Paper (8.5inx11in, sheets, white)	1
Worksheets: Electromagnetic Spectrum	1

Goal: To learn how UV light can activate fluorescence in highlighter pen ink.

Survey Connection:



- R.** What causes sunburns and makes fluorescent highlighters glow?
B. Ultraviolet (UV) light

Procedure:

1. Each student should use the yellow marker to create a solid rectangle (roughly 2inx3in) on their white papers.
2. Use their yellow highlighter to create a second solid rectangle (roughly 2inx3in) below the darker yellow rectangle (leave some room in between – see picture to the right).
3. Each student should have a blue LED flashlight (blue is similar to ultraviolet on the electromagnetic spectrum).
4. Turn off the lights in the room. If turning off the lights does not seem dark enough, encourage students to conduct the experiment under their desk/table, under their coats, or move to a darker corner of the room, etc. They'll need to either dim their laptop screen, put a shirt over the screen, or turn the laptop away from themselves, etc. while they proceed.

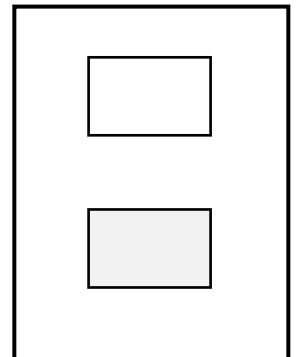

Discussion Prompt:

Virtual Learning:

Session II

- **What do you think will happen when we shine UV light on the yellow marker?**

5. Have the students shine the blue light on the patch of yellow marker, and let the groups discuss what they see. You can have students fold the paper over, so that they only see the yellow rectangle.

Discussion Prompts:

- **What do you think will happen when we shine UV light on the highlighter rectangle?**

6. Have students shine the blue LED onto the highlighter rectangle.

Discussion Prompts:

- **How is the highlighter different from the plain yellow marker?**

7. Explain to students that *the highlighter is fluorescent, meaning that it can absorb UV light and emit it as visible light. The blue light excites the fluorescent dye in the highlighter which reflects light back to us as a glow that we can see.*

Discussion Prompts:

- **What would happen if we put the highlighter into water?**

8. Turn the lights back on and have students prep one 9oz plastic cup half-filled with water.
9. Have students uncap their highlighter, then swirl the highlighter around in the water with the tip down. The highlighter should stay in the cup while students proceed with the activity.
10. Once the dye has seeped into the water, have students get their LED lights ready (don't turn them on yet), and turn off the room lights.
11. Observe what the water looks like without the LED on.
12. Have students hypothesize about what will happen once they shine their blue LED lights on their water.
13. Have students aim their blue LED light towards the water and turn it on. Students will observe the water glowing.
14. Turn on the lights and observe the cup again.



Discussion Prompts:

- **Why did the highlighter ink stop glowing when you turned the lights off?**
- **Did the water glow by itself or did it need light from a different source (e.g. blue LED light) in order to emit the light back outward as a glow?**

The Science Behind It:

A black light gives out light in the ultraviolet (UV) range. The UV light is invisible to our eyes, but when the black light shines on something fluorescent, some of the UV light

Virtual Learning:

Session II

gets converted and reflected back to us as visible light, which we see as a glow. There are lots of uses for fluorescence. Some light bulbs are fluorescent. Electricity adds energy to a gas inside, and that gas gives off UV light. The UV light hits a fluorescent coating inside the bulb, making it glow. That's why sometimes lights start out dim and get brighter the longer they are on - it takes a while to build up enough UV light to get the coating to fluoresce and glow. Some scorpions fluoresce. Their exoskeleton (the hard outer layer) has chemicals inside of it that glow under a black light. No one knows why scorpions glow, but it is possible this helps them see better in the dark by picking up light from the stars. (http://www.energystar.gov/index.cfm?c=cfls.pr_cfls_about#how_work, <http://blogs.discovermagazine.com/notrocketscience/2011/12/23/why-do-scorpions-glow-in-the-dark-and-could-their-whole-bodies-be-one-big-eye/>)

Activity Source: <http://www.stevespanglerscience.com/experiment/black-light-secret-message>, <http://www.sciencekids.co.nz/experiments/glowingwater.html> & http://www.ehow.com/how_7783236_make-glowing-water-black-light.html

Activity Three – Fun House Mirrors

Time: 20 Minutes

Supplies:

General Supply Bag	#
Pencil	1
Lab Notebook	1
Tape (roll)	1
Class 3 Supply Bag	#
Mirror Board Sheets	1
Mirrors (2inx3in)	1
Folder	#
Paper (8.5inx11in, sheets, white)	2

Goal: To study how changing the shape of a mirror changes its reflective properties using flexible mirror boards.

Procedure:

1. Each student should have a flexible mirror board sheet.
2. Have students explore by bending the mirrors and making observations.
3. Have students hold the mirror by the edges without bending it. Students should close one eye, or cover one eye with their hand, and look at their **reflections** in the mirror.
4. Then, have students gently squeeze the left and right edges of the mirror together so the center of the mirror bulges away from them, leaving the left and right side closer to them. This should create the illusion of the student's face splitting in two and then coming back together.

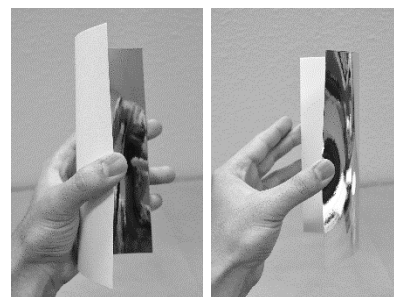

Discussion Prompts:

- **Can you change the way you look in this mirror by bending or moving it? Can you make yourself look narrower or wider? Can you flip your image upside-down? What did you do to the mirror to make that happen?**
 - **If you bend the mirror top to bottom so that it bulges towards you, do you look smaller or larger? What about if you bend it the opposite direction?**
 - **What would happen if you wrote something and then looked at it in a mirror? Let's find out!**
5. Each student should have a sheet of paper and a pencil.

Virtual Learning:

Session II

6. Have students write their name on the paper.
7. Have students look at their writing in the mirror. Students should experiment with bending the mirror to change the orientation of the reflected text.
8. Have each student try to write their name backwards so that it appears forwards when reflected in a flat mirror.
9. Each student should have a 2inx3in mirror.
10. Have students fold their paper hamburger-style (bringing the two short ends together) and open it back up.
11. Have students write their name HEAVILY with the pencil (not pen) on the inside of the folded sheet.
12. Have students refold the paper and rub firmly on the blank, outer part of the sheet to transfer the pencil image inside the folded paper. Unfold the paper.
13. Have students use their pencil to write over and darken the transferred design.
14. Have students hold their 2inx3in mirror upright with one edge on the paper, above the transferred image. The transfer image should appear "normal", or right-side-up in the mirror.
15. Have students write the word "TOT" in capital letters on their paper.
16. Have students hold their 2inx2in mirror upright with one edge on the paper, along one side of the word "TOT."
17. Have students look at the word in the mirror. They should notice that the word looks the same.
18. Have students draw a vertical line down the center of the letters "T" and "O." Students should notice that the shapes of the letters are the same on either side of the vertical line, indicating that the word TOT is **symmetrical**.
19. Allow students some time to explore and experiment with other shapes, letters, numbers, or words.
20. Have students write a short sentence on one side of the paper.
21. Have students look at their writing in the mirror. It should appear reversed.

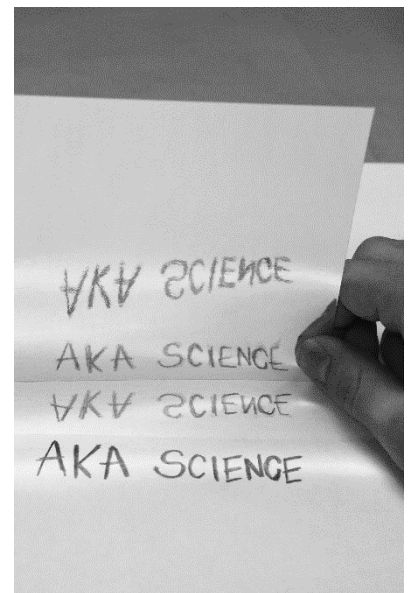
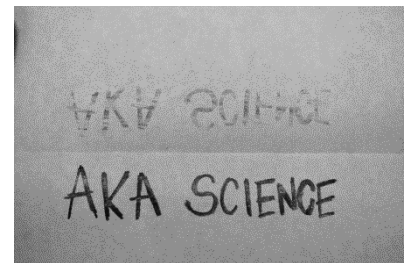

Discussion Prompts:

- **How could you use what you know about mirrors to write a secret message?**

22. Each student should prepare another sheet of paper.
23. Have students copy the reversed writing they see onto the second sheet of paper.
24. Show it to friends or family to see if they can decipher the message, first without and then with mirrors.

Virtual Learning:

Session II

The Science Behind It:

Normally, light travels in a straight line when it's reflected off of a flat mirror. A bent mirror, however, reflects light in a different way than a flat mirror due to its curved shape. There are two types of curved mirrors. Mirrors that bend inwards like a cave (the middle is farther from you when you're looking at it) are called concave mirrors. Mirrors that bulge outwards (the middle is closer to you) are called convex mirrors. Curved mirrors are used for lots of things. Concave mirrors take light rays that are farther apart and focus them on a point in front of the mirror. They can be used to magnify a reflection, like in a makeup compact, or to focus light on an object (and start a fire!). Convex mirrors take light rays that are closer together and spread them out. They are often used in hallways because their shape allows you to see around corners and avoid walking into someone. You might notice them in convenience stores or on the corners of driveways.

(www.physicsclassroom.com/class/refln/Lesson-3/The-Anatomy-of-a-Curved-Mirror)

Activity Source: *49 Easy Science Experiments with Optics* by Robert W. Wood,
www.teachnet.com/lesson/art/mirrorflipimages.html & www.exploratorium.edu

Activity Four – Not in Kansas Anymore

Time: 10 Minutes

Supplies:

General Supply Bag	#
Pencil	1
Lab Notebook	1
Scissors	1
Tape (rolls)	1
Class 3 Supply Bag	#
Wooden tops (spinners)	1
Folder	#
Worksheets: Benham's Disk (quarter sheets)	1

Goal: To show how the brain can be tricked into seeing black and white as color using Benham's Disk.

Procedure:

1. Each student should have a Benham's Disk worksheet.

Discussion Prompts:

- **What do you see when you look at this disk? What do you think we might use it for?**
- **What might we see if we spin the disk very fast?**

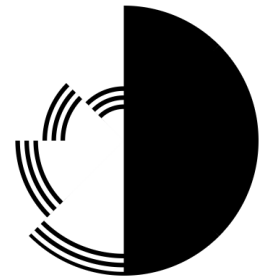

2. Each student should have one wooden top. Invite them to practice spinning their top a few times in each direction.
3. Have students gently poke their wooden spinners through the center of the paper Benham's Disk, so that the disk comes to rest on the topside of the spinner's base. The pencils from General Supply kits can be used to start a central hole on the paper disk if students have trouble using the spinner to poke the hole. Tape can be used to secure the disk to the wooden spinner base, if the fit is not snug enough.

4. Have the students hypothesize about what they think they'll see when they spin their wooden tops, then invite them to give their tops a whirl. Ask them to focus on the black bands and see if anything changes.

Note: in order to see the effect, they will have to spin it consistently, evenly and pretty quickly.

5. Encourage your students to try spinning their top in both directions (clockwise and counter-clockwise) and note any differences.

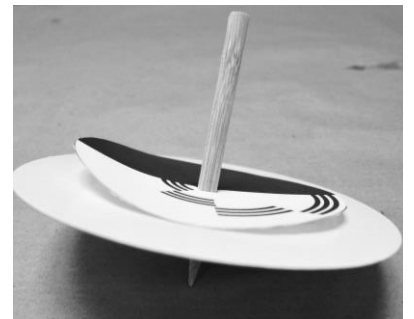

Virtual Learning:

Session II

Discussion Prompts:

- **Do you observe any differences when you spin the disk in the opposite direction?**
 - **Why do you think we're seeing colors when they're aren't any?**
 - **Do you think other patterns might create similar effects or optical illusions?**
6. **OPTIONAL:** If there is extra paper readily available in your students' homes or left from the previous activity, students are free to cut out their own blank disks to decorate or attempt to design their own optical illusion pattern to put on their wooden top and see what happens!

The Science Behind It:

The "Artificial Spectrum Top" invented by Mr. C.E. Benham was first released in 1894 as a toy to study optics. The disc is special because its rotating black and white pattern fools the viewer's brain into seeing color! Scientists are still debating why our brains perceive color in these circumstances. One of the top theories is related to persistence of vision and suggests the alternating black white pattern triggers our eye's color sensors into thinking we're seeing color. Other Benham patterns are available online. Try them out and see what colors they reveal! (<http://faculty.washington.edu/chudler/benham.html>)

Activity Source: *Awesome Experiments in Light & Sound, Michael DiSpezio and Catherine Leary*

CLASS 4: EXPLORE FORCES (BUILD WITH PHYSICS & ENGINEERING)

Activity One – Gumdrop Toothpick Tower

Time: 30 Minutes

Supplies:

General Supply Bag	#
Pencil	1
Lab Notebook	1
Tape (rolls)	1
Class 4 Supply Bag	#
Cardboard (12"x12")	1
Gumdrops (3.25 oz portions)	1
Toothpicks (bag)	1
Folder	#
Towers of the World Worksheet	1

GOAL: Using criteria and constraints, design and create a stable tower.

Procedures:

1. Start a discussion about towers; *what do we know about towers?*

Discussion Prompts:

- **Have you ever tried to build a structure out of Legos or building blocks?**
 - **How did you decide what to build?**
 - **How did you know what you build will work, and not fall down?**
 - **What do you think gravity does? Why is this important in building things?**
 - **What is a tower? What does a tower look like? What does it do? How is it built?** (A tower is taller than it is wide. It can be a lookout point, save limited space, provide maximum visibility for things like clocks, or they can be monuments.)
 - **How would you go about building a tower out of a soft material, like marshmallows or gumdrops?**
2. Explain that they will be building a tower but must follow certain criteria and constraints:
 - **Criteria** are things you or your design need to accomplish.
 - **Constraints** are ways that you or your design are limited.

Virtual Learning:

Session II

- Have students look at the Tower Worksheet. On the worksheet are examples of towers from throughout human history.

Discussion Prompts:

- **What do all these towers have in common?**
 - **How are they different from one another?**
 - **Which tower seems like it would best handle an earthquake vs a hurricane?**
 - **What design is tallest?**
 - **Which tower do you think would be most stable in a variety of conditions?**
 - **How could we make a tower both tall and stable?**
- Students should have an equal portion of toothpicks and gummy dots. Invite students to make 3-D shapes with the materials (e.g. triangle/pyramid, cube, hexagonal column, etc.) and note which shapes seem the most stable.
 - Introduce the activity **criteria and constraints** and facilitate a discussion of how they could build a tower using the materials provided, based on the shapes that they found to be the most stable.

Criteria:

- ✓ Your tower must be at least 1 foot tall.
- ✓ Your tower must stand for 1 minute without collapsing.
- ✓ The tower must stand independently (e.g. no fingers holding it up!)
- ✓ Your tower must have a foundation (i.e. base) that can be moved and lifted. The cardboard can act as a base, if needed.

Constraints:

- ✓ You have 10 minutes to engineer your design.
 - ✓ You can only use the materials provided.
 - ✓ You cannot test the tower until the *designated* testing time.
 - ✓ You cannot touch your tower once testing begins.
- Allow students 5 minutes to plan their tower design using their lab notebook and a pencil.
 - Provide 10 minutes for the engineering their design.
Note: there is no particular design for them to follow—this is purely creative and experimental.
 - Once time has elapsed, have students test their towers to see if they can stand unassisted. Students can use a ruler to measure their creation's height.
 - Invite students to take another 5 minutes to make improvements to their design, and then try again.
 - Using their lab notebooks, encourage students to reflect on the strengths and weaknesses of their designs, and any challenges they overcame.

Examples of Toothpick Towers:

Virtual Learning: Session II

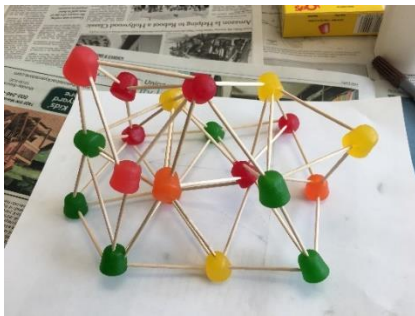
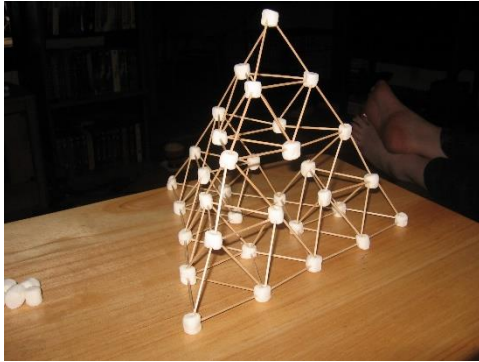

The Science Behind It:

What does it mean to be an engineer? What do you think engineers do? Why do people choose to be engineers? Let's find out from some real engineers!

Alison Delahunty is an engineer who helps designs roads and bridges. She became an engineer because of how much she enjoyed learning about the impressive human-made structures all around her. Alison was inspired by architecture, dams, and bridges as a child and decided she wanted to be a part of creating those things herself. Working as an engineer she says, "I love a challenge and that is something engineering provides every day. You're presented with a problem and you use your knowledge and common sense to produce a solution."

Louise Campion is an engineer who works on making our roads and electricity more environmentally friendly. Louise says she's always been an "engineer at heart" because of her creativity and curiosity. She loves designing and problem solving- the two things she gets to do most as an engineer! Her love for engineering goes beyond the fun though. She says, "Ultimately, I believe that engineers are at the heart of communities and serve to improve them- I want to be a part of that and contribute to the betterment of society and the environment." Thanks for all your hard work Alison and Louise! (<http://www.engineersjournal.ie/2018/03/06/three-stories-why-i-became-an-engineer/>)

Building and innovating to solve a problem is one of the most basic human instincts. From the invention of the wheel to present day marvels like Burj Khalifa, the tallest skyscraper in the world, people across the globe are constantly engineering!

Activity Two – Pinwheels

Time: 5 Minutes

Supplies:

General Supply Bag	#
Pencil	1
Lab Notebook	1
Scissors	1
Tape (rolls)	1
Class 4 Supply Bag	#
Brass Brad	1
Square paper (green, pre-punched)	1
Pencils (new, with fresh erasers)	1

Goal: Learn to understand axles by creating a basic pinwheel.

Procedure:

1. If desired, read the following history of pinwheels.

In our second activity today, we'll be making pinwheels. Pinwheels may be a fun, colorful delight at present-day fairs and amusement parks, but did you know they've been around for more than 2,000 years?

The pinwheel was first brought to the United States in 1919 by Tegrin Samour, a toy maker who immigrated to the U.S. from Armenia. These pinwheels were originally sold as "wind wheels". However, pinwheels (or whirligigs) have been around even longer than that! They were first engineered in China around 400 BC and are still popular there today. Known as jixiang lun in Mandarin, these pinwheels are intricate crafts and decorations used during Chinese New Year (Spring Festival) celebrations. They are symbols of luck and blessings for the coming year. Different colors can have different meanings, and it is common to see multiple pinwheels displayed together. (<https://abtnews.com/a-chinese-new-year-money-spinner-beijings-lucky-spring-festival-pinwheels>, <https://blomus.us/blogs/blomus-blog/pinwheels-a-childhood-tradition-all-grown-up>)

Discussion Prompts:

- **How do wheels spin?**
 - **What sorts of things rely on an axle?**
 - **Have you ever ridden a carousel or a Ferris wheel?**
 - **Why are wheels useful?**
2. Ask students if they've ever seen a pinwheel before and discuss how they work.
 3. Explain the idea of an axle to your students.

Virtual Learning:

Session II

4. Each student should have a piece of pre-punched Origami Paper, a ruler, a sharpened pencil, and a pair of scissors.
5. If time allows, invite students to decorate their paper.
6. Instruct students to fold their piece of paper diagonally into a triangle in one direction, then unfold it and do the same on the other side. This should create an "X" crease across the paper.
7. Instruct students to cut along each arm of the "X" crease about 2/3 of the way towards the center of the Origami Paper. DO NOT cut all the way to the center of the paper. Repeat until there are approximately 4 equal cuts in the paper.

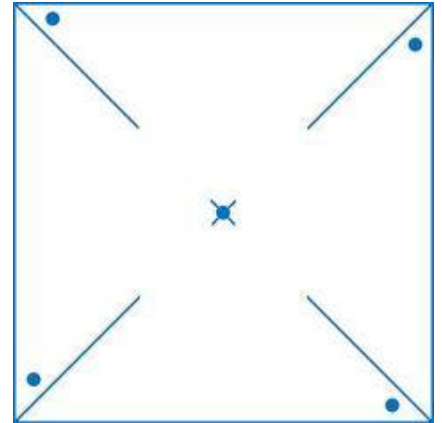

TIP: It may be helpful to measure out and draw the lines you will be cutting in advanced.

8. The Origami paper should now have 4 equal triangular flaps. Their papers should look similar to the image on the right.
 9. Have students make an additional hole in the very center of their papers using their pencil tips (at the cross of the "X"). Widen the hole by wiggling the pencil through it.
 10. Use tape to reinforce any rips or tears as they happen.
 11. Students should have a brass brad and a new pencil with a fresh eraser.
 12. Instruct students to gently fold the hole-punched side of each triangle flap towards the center of their paper, threading the brass brad through each hole as they go.
 13. Put the brass brad through the central hole.
 14. Push the ends of the brass brad through the new pencil eraser, until they appear on the other side, and then fold the brad ends down.
- Note:** If it is too difficult for your students to push their brads through the erasers, or a brad becomes bent, you can simply wrap the brad around the top of the pencil to hold the pinwheel in place.
15. Gently rotate the paper pinwheel around the brad axel until you have widened all the holes enough for it to spin freely.
 16. Blow on the pinwheel to make it spin or hold it outside in a breeze.

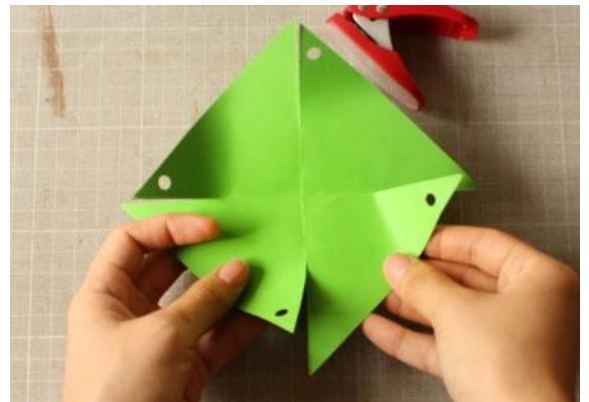

Discussion prompts:

- *What could you improve about this design?*
- *What about the material was challenging?*
- *What worked? What didn't work?*
- *What did we learn about axels?*
- *What would you do differently next time?*

Virtual Learning:

Session II

- *What skills did you use to complete this challenge?*

The Science Behind It:

Wheels are everywhere: roadways, sidewalks, skate parks, ceramics studios, and carnivals—even most doorknobs work with a wheel mechanism. But as common as wheels are, they haven't always been around. The invention of the wheel was a massive engineering step for humanity. The first wheels were used to make pottery in Mesopotamia, the ancient Middle East, around 3500 B.C. (over 5,000 years ago)! For millennia people relied on nature for invention inspiration, but no wheels are found in nature—no other organisms have free rotating parts or use wheel-based tools. They are an entirely human idea! (<https://www.smithsonianmag.com/science-nature/a-salute-to-the-wheel-31805121/>)

Wheels rotate on an axle. The axle can either turn with the wheels, or be secured to a fixed point with the wheels rotating around it. Wheels are as round as possible to be balanced, and reduce friction. This reduction in friction is what makes wheels so useful in transportation. Trying to move a heavy object across ice is easier than it is across asphalt, all because friction forces are stronger on asphalt. When lifting something up, you are fighting gravity. When pushing something forward, you are working against friction. The more of an object's surface area is in contact with the ground, the more friction occurs. When you put an object on wheels, you are limiting friction by cutting down on the surface area of the object that contacts the ground.

(<https://www.explainthatstuff.com/howwheelswork.html>)

Activity Source: A step-by-step tutorial for a similar design is also available here: <https://www.instructables.com/id/Pinwheel/>

ACTIVITY PHOTOS:

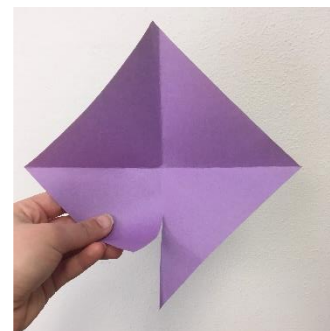
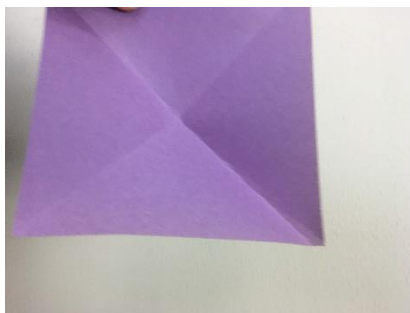
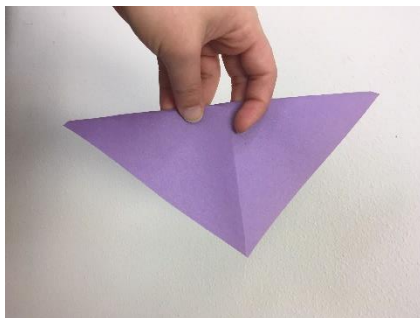

Virtual Learning: Session II

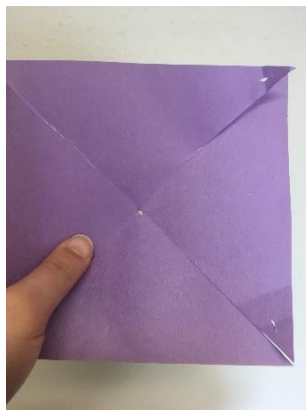
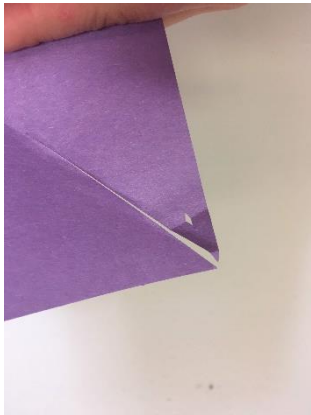

Activity Three – Spool Racer

Time: 20 Minutes

Supplies:

General Supply Bag	#
Pencil	1
Lab Notebook	1
Scissors	1
Tape (rolls, Scotch)	1
Class 4 Supply Bag	#
Pennies	1
Popsicle sticks (mini)	1
Rubber bands (size 16)	1
Spools (wooden, 1in)	1
Straws (clear, full size)	1
Washers (small)	1

Goal: To observe how rubber bands can store up potential energy and convert it to kinetic energy by building a spool racer.

Procedure:

1. Facilitate a discussion about potential and kinetic energy.

Discussion Prompts:

- **What happens when you stretch a rubber band and then let it go?** (It springs back to its original shape—and in some cases, flies through the air.)
 - **What do we call the energy that's stored in the rubber band when you stretch it out?** (Potential energy! Potential energy is energy that's stored up for future use.)
 - **What do we call the energy that's released as the rubber band springs back?** (Kinetic energy! Kinetic energy is the energy of motion.)
 - **Do you think we use a rubber band's ability to store potential energy and release kinetic energy to make something move? Let's try!**
2. Each student should have a spool, a size 16 rubber band, a washer, a penny, a straw, and a mini popsicle stick.
 3. Have students:
 - a. Thread the rubber band through the hole of the spool until it pokes through the other side (use the straw to push it through). This will create two rubber band loops sticking out from the spool (one on each end).
 - b. Hold one rubber band loop and insert the straw into the other loop to prevent the rubber band from sliding back inside the spool.

Virtual Learning:

Session II

- c. Insert a penny into the rubber band loop that doesn't have the straw. Make sure the penny is centered on the flat outer part of the spool and the rubber band is laying flat. Pull the loop with the straw to tighten the rubber band over the penny.
- d. Put a piece of tape over the rubber band and penny to hold them in place (see photo at left). Press the tape down around the rim of the spool to smooth it out as much as possible.
- e. Remove the straw from the other rubber band loop and thread a washer onto the loop. (One side of the washer is flatter than the other—make sure the flatter part is facing the spool.) Push the washer against the flat outer part of the spool and pull the rubber band tight so the loop sticks out of the spool and washer.
- f. Slide the tip of the mini popsicle stick through the rubber band loop. The longer end of the popsicle stick is now a “handle.”
- g. Hold the spool sideways in one hand. Line up the popsicle stick handle so that it's facing toward you with the flat side up (see photo at left).
- h. Use a finger at the outer edge of the handle to wind it forward around the washer 10-15 times. Place the spool racer on the floor with the wound-up handle pointed toward you. Let it go.



Discussion Prompts:

- **What happens?** (The spool rolls along the floor by itself!)
 - **How does it work?**
 - **What kind of energy is the spool racer using?** (Winding the rubber band with the handle builds up potential energy. When you let go of the handle, the rubber band starts to unwind, and the stored potential energy is converted to kinetic energy, making the spool move. It's like a rubber band motor!)
- i. Allow students to experiment with the spool racer.

- TIPS:**
- **Don't overwind the handle** (20 rotations is a good limit). If the rubber band gets overwound, it gets stuck inside the spool, and the spool can't move.
 - **If the spool stops moving too soon**, try pulling the handle away from the spool to undo any kinks in the rubber band.
 - **Make sure the rubber band has fully unwound before rewinding it.** You may need to pull the handle away from the spool to physically unwind it.

Discussion Prompt:

Virtual Learning:

Session II

- ***Do you think the spool racer will work with something other than the mini popsicle stick? Let's find out!***
4. Have students remove the mini popsicle stick and insert the tip of the straw into the rubber band loop. Use the long side of the straw as the "handle" to wind the rubber band.
 5. Have students experiment with the new version of the spool racer. If desired, students can experiment with cutting the straw to different lengths to see how it affects the spool racer's performance.

TIP: In case a rubber band chain breaks and you need to make a new chain: To link two rubber bands together, lay them on a flat surface with the left one overlapping the right one slightly in the middle. Take the left side of the right rubber band and fold it over the right side of the left rubber band, then pull it under the farthest right part of the right rubber band. Pull to tighten. Repeat to add one more rubber band to the chain.

The Science Behind It:

Energy is always changing into different forms! Potential energy is energy that can be used in the future. When you wind the rubber band, you're using kinetic energy (the motion of winding) to store up potential energy in the rubber band. If you keep twisting the rubber band, you can store up even more potential energy. After you let go of the rubber band, the potential energy turns into kinetic energy! Kinetic energy is the energy of motion, and it allows the spool racer to move across the floor. The spool stops moving once the stored potential energy has all been converted into kinetic energy and used up. (Chemistry and Physics for Nurse Anesthesia: A Student-Centered Approach (2nd edition) by Shubert, David, Leyba, John pg. 97-98), Interactive Science For Inquiring Minds Volume B, Volume 2 by Tho Lai Hoong, Tho Mun Yi, & Josephine Fong pg. 5)

Activity Source: www.pbs.org/saf/1103/teaching/teaching3.htm

Activity Four – Cartesian Diver

Time: 15-20 Minutes

Supplies:

General Supply Bag	#
Pencil	1
Lab Notebook	1
Scissors	1
Class 4 Supply Bag	#
Bottled water (16oz bottles)	1
Cups (20oz plastic)	1
Paper clips (regular size)	4
Rubber bands (size 33)	1
Straws (bendy tip, striped, full size)	1

Goal: To demonstrate that applied force can change pressure and cause motion using a straw-and-rubber-band Cartesian diver.

SURVEY CONNECTION:

This activity is linked to the following survey question:



Q. True or False: Air pressure affects whether an object sinks or floats

A. True

Procedure:

1. Facilitate a discussion about how certain objects interact with water.

Discussion Prompts:

- **What happens when you drop a stone in water? (It sinks.)**
- **What happens when you drop a piece of foam in water? (It floats.)**
- **Do you think there are any objects that could both sink and float in water? Let's find out!**

2. Each student should have a 20oz cup filled three-quarters full of water. This activity might be best done at a sink or in a basin or Tupperware of some sort to catch any water that might spill.

Virtual Learning:

Session II

3. Each student should also have a rubber band, four paper clips, scissors, and a striped bendy straw.

4. Have students:

- Bend the bendy part of their straw over so the short side of the straw almost touches the long side.
- Cut the long side of the straw to make it the same length as the short side. There should be an equal length of straw on both sides of the bend.
- Wrap a rubber band around the bottom of the bent straw piece several times. The rubber band should be near the straw openings, away from the bent part. This is now the "diver" (see diagram on right).
- Test to see if the diver floats by putting it in the cup of water.
- The goal is to have the tip of the diver (the bent part of the straw) bobbing just above the surface of the water (see photo below on right). If more than the tip is sticking out above the water, add paper clips one at a time by hanging them onto the rubber band. Each paper clip should hang down away from the bent part of the straw, making the diver look a bit like an octopus (see diagram above). Test the diver after adding each paper clip until it floats correctly.

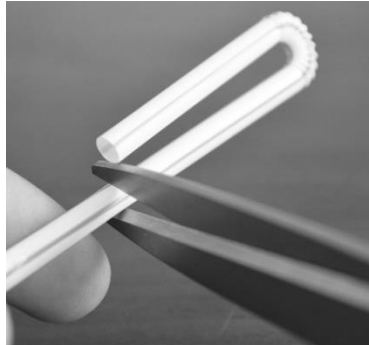

Bent part of bendy straw

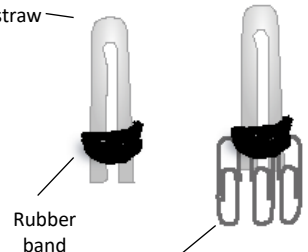

Hang paper clips on the rubber band until the diver floats correctly

5. When students are ready, access their water bottle.

6. Have students:

- Remove the label from their water bottle and throw it away.
- Hold their water bottle over the sink or basin (to catch any overflow), remove the cap, carefully put their diver in the bottle.).



Virtual Learning:

Session II

- c. Add water from the 20oz cup if needed to top off the water bottle. The Cartesian Diver works best when the bottle is filled to the brim.
- d. Screw the cap back on the water bottle tightly. The water bottle should be as full as possible before putting the cap back on. The diver should float inside the bottle.

Discussion Prompts:

- **Does the diver sink or float?** (It floats.)
 - **Do you think you could get it to sink? How?**
7. Have students firmly squeeze and hold the sides of the bottle, then release.

Discussion Prompts:

- **What happened?** (The diver sank down when the sides were squeezed, then floated back up when the sides were released.)
- **Why does this happen?** (When the sides of the bottle are squeezed, the air inside the bottle is compressed, which affects the diver's buoyancy.)

The Science Behind It:

Why did the diver float when you put it in the bottle? There is a tiny bubble of air trapped in the bent straw. That was enough to make the diver less dense than the water, so it floated at the top. When you squeezed the bottle, you put pressure on the water and everything inside the bottle—including the air bubble. The extra pressure made the air bubble inside the straw smaller, which changed the density of the diver. Now that the diver was denser than the water, it sank to the bottom. When you let go of the bottle, you removed the pressure on the diver and it was able to float back to the top. It's all about balancing the forces of gravity, which pulls the diver down, and buoyancy, which helps the diver float!

What else uses density to move? A submarine uses density to dive and then come back up to the surface. A submarine has ballast tanks that can be filled with water to make it sink, or with air to make it float. By adjusting how much air or water is in the tanks, you can determine exactly how deep the submarine goes. (<http://www.physics.org/interact/physics-to-go/cartesian-diver/>, <http://courses.education.illinois.edu/CI241-science-Sp95/resources/philoToy/philoToy.html>)

Activity Source: <http://www.sciencetoymaker.org/diver/assembly.html>



Post-Activity: AKA Science Post-Survey

- **Please conduct a pre-survey** at the **BEGINNING of the FIRST class** by asking the questions below and **record each student's response**.
- **Read each question and its possible answers aloud** as well as typing the questions/possible answers into the chat box of your virtual learning platform.
- **Have students close their eyes** or put their heads down (for anonymity among peers) and **respond to the questions by raising their hands**.
- **Record each student's response** (e.g. Kerry said "boring", Kevin said "fun", Karim said "Sorta fun"). Students' responses will be compared to their post-survey responses at the end of the program to assess learning growth.
- **If it is easier for your students, they can also fill out a google form**. This can be found at www.tinyurl.com/AKAWinter2020postsurvey.
- **Please note that stamped postcards with the pre- and post-survey questions are in each student's folder**. While an emailed record from Class Leaders is preferred, the postcards are an option if that is not feasible.
- **All student responses must be passed along to Kathryn Sechrist** (ksechrist@impactnw.org).

SURVEY QUESTIONS:

1. **Do you think that science is _____?**
 - a) Fun
 - b) Sort of fun
 - c) Boring
2. **Do you like doing science experiments?**
 - d) Yes
 - e) Sort of
 - f) No
3. **Do you want to learn more about science?**
 - d) Yes
 - e) Sort of
 - f) No
4. **What do you call the features of living things that help them survive?**
 - a) Classification
 - b) Adaptations
 - c) Dispersals

Virtual Learning:

Session II

5. When you add Alka-Seltzer to water, what gas is produced that causes it to bubble and fizz?

- a) Laughing Gas
- b)
- c) Water Vapor

6. True or False? Ultraviolet (UV) light causes fluorescent highlights to glow.

- a)
- b) False

7. True or False? Air pressure affects whether an object sinks or floats:

- a) True
- b)

WE HOPE YOU HAD A GREAT TIME ON YOUR
VIRTUAL **AKA SCIENCE** LEARNING ADVENTURE!



Thank you: